

Cooper Bussmann

Homepage
About Cooper Bussmann
Contact Us
Privacy
Legal
Cooper Bussmann® Brand
Site Map

S506-6.3-R

TIME DELAY, 5 X 20 mm, GLASS T

Product Information

Product Type:	Fuse
Product Family:	Electronic
Brand:	Cooper Bussmann

Recommended Products

Rec. Fuse Block:	HTC-15M
Rec. Inline Fuse Holder:	HHT
Rec. Panel-mount Fuse Holder:	HTB Series
Rec. Fuse Clips:	1A3399 Series

Physical Properties

Dimensions:	0.79in.(L) × 0.19in.(W) × 0in.(H)
-------------	-----------------------------------

Electrical Properties

Maximum AC Voltage:	250
Amperage Rating:	6.3
AC Interrupting Ratings:	<ul style="list-style-type: none">• 63 at 250V
Time Delay:	Yes

5 x 20mm Fuses

S506 Series, Time-Delay, Glass Tube

Description

- Time-delay, low breaking capacity
- Optional axial leads available
- 5 x 20mm physical size
- Glass tube, nickel-plated brass endcap construction
- Designed to IEC 60127-2 (32mA-10A)

S506 Electrical Characteristics								
I_n	$2.1 I_n$		$2.75 I_n$		$4 I_n$		$10 I_n$	
	max	min	max	min	max	min	max	
32mA-100mA	2 min	200 ms	10 sec	40 ms	3 sec	10 ms	300 ms	
125mA-6.3A	2 min	600 ms	10 sec	150 ms	3 sec	20 ms	300 ms	
8A-15A	2 min	600 ms	10 sec	150 ms	3 sec	20 ms	300 ms	

Agency Information

- UL Recognized Card: (32mA-15A) Guide JDYX2, File E19180
- CSA Component Acceptance: File 53787, 50mA-10A
- cURus Recognition: Guide JDYX8, File E19180
- SEMKO Approval, 32mA-10A
- VDE Approval, 32mA-10A
- BSI Approval, 32mA-10A
- IMQ Approval, 32mA-10A
- PSE Approval, 1A-15A
- CCC Approval, 32mA-6.3A

Ordering

- Specify packaging, product, and option code



Dimensions - mm

Drawing Not to Scale

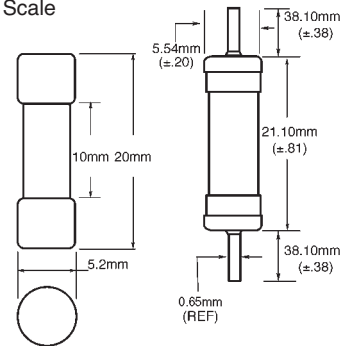

- Ratings above 4A have a 0.8mm diameter lead
- With TR2 packaging code, lead wire length is 19.05mm

Specifications

Product Code	Voltage Rating Vac	Interrupting Rating at Rated Voltage (50Hz) Vac	Typical DC Cold Resistance (Ω)*	Typical Melting I ² t (amps)	Typical Voltage Drop (mV)‡
S506-32-R	250	35	21.0	0.0051	1050
S506-40-R	250	35	13.90	0.0072	920
S506-50-R	250	35	9.24	0.0095	800
S506-63-R	250	35	6.96	0.021	760
S506-80-R	250	35	4.42	0.038	580
S506-100-R	250	35	2.74	0.045	490
S506-125-R	250	35	1.97	0.063	390
S506-160-R	250	35	1.27	0.093	320
S506-200-R	250	35	1.00	0.114	340
S506-250-R	250	35	0.640	0.265	270
S506-315-R	250	35	0.450	0.621	250
S506-400-R	250	35	0.308	0.872	210
S506-500-R	250	35	0.183	0.827	140
S506-630-R	250	35	0.186	1.33	150
S506-800-R	250	35	0.128	2.78	75
S506-1-R	250	35	0.0757	6.45	87.5
S506-1.25-R	250	35	0.060	10.05	86
S506-1.6-R	250	35	0.0425	21.7	82
S506-2-R	250	35	0.03325	31.6	77
S506-2.5-R	250	35	0.026	59.4	75
S506-3.15-R	250	35	0.0185	96.4	68.5
S506-4-R	250	40	0.0139	71.8	67
S506-5-R	250	50	0.00985	142.5	60.5
S506-6.3-R	250	63	0.0071	237.6	51
S506-8-R	250	80	0.006	255.8	55
S506-10-R	250	100	0.004	450	54
S506-12.5-R	250	125	0.004	1019.5	45
S506-15-R	250	125	0.004	1091.7	73

* DC Cold Resistance (measured at <10% of rated current)

‡ Typical Voltage Drop (voltage drop was measured at 20°C ambient temperature at rated current)

Nominal Time-Current Characteristics of S506-R

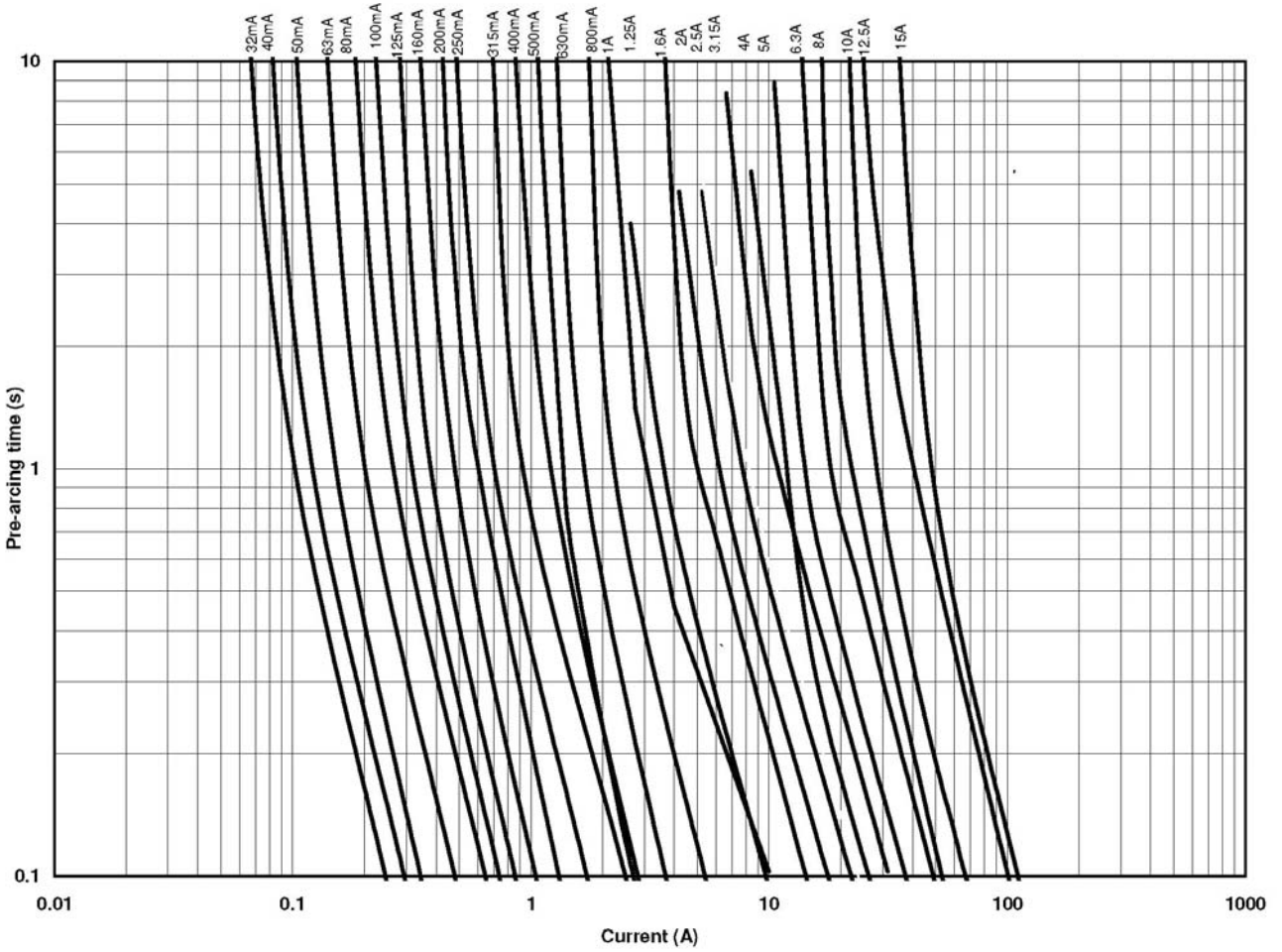

Packaging Code

Packaging Code Suffix	Description
BK	100 pieces of fuses packed into a cardboard carton
BK1	1,000 pieces of fuses packed into a poly bag
TR2	1,500 pieces of fuses packed into tape on a reel (19.05mm lead wire length)

Option Code

Option Code	Description
V	Axial leads - copper tinned wire with nickel plated brass overcaps